

The Hydrobatic Dual-Arm Intervention AUV Cuttlefish

Leif Christensen, Jens Hilljegerdes, Michael Zipper, Andrej Kolesnikov, Benjamin Hülsen,
Christian Ernst Siegfried Koch, Marc Hildebrandt and Leon C. Danter

*Robotics Innovation Center
German Research Center for Artificial Intelligence
Bremen, Germany
leif.christensen@dfki.de*

Abstract—This paper presents the basic concept, mechatronic design as well as the control and navigation approaches of the hydrobatic dual-arm intervention AUV *Cuttlefish*. Designed for autonomous manipulation of subsea structures, the AUV was developed with some unique features: 1) the ability to take arbitrary poses in the water column to reach even difficult to access objects with its two specifically designed manipulators, 2) the ability to change the center of gravity and the buoyancy to tune more towards stability or towards agility and 3) a docking interface with fast data transfer when connected and thus allowing for human remote control aside from the autonomous operations. Designing the internal communication on the system we followed the paradigm that every data source should be a standalone communication node, so that not only internal subsystems, but also the remote control center as well as further third party data handlers could subscribe to the information needed. With autonomous subsea intervention still being a field of active research, we conclude with an outlook on the next envisioned steps for the work with the *Cuttlefish* AUV and name possible ways to use AI to further push the autonomy and robustness of future intervention AUVs.

Index Terms—robotics, AUV, underwater, AI, manipulation

I. INTRODUCTION

With the blue economy growing, the number of corresponding subsea infrastructures is going up as well. Especially the amount of aquaculture installations and offshore wind farms with their corresponding foundation structures are rapidly increasing [1]. At the same time, regulations for the sensitive marine ecosystem are getting more strict, raising the demand for automated subsea operations not only for these emerging markets, but also for the traditional oil and gas industry.

Traditional human diving operations are not only dangerous and highly dependent on the weather, but are also possible only down to shallow depths. It is also foreseeable, that the capacities of human diving operations will not be sufficient [2]. For greater depths, Remotely operated Vehicles (ROVs) are used, which mostly require large Offshore Service Vessels (OSV) equipped with sophisticated Tether Management Systems (TMS) and Dynamic Positioning (DP) capabilities, making ROV operations extremely time-consuming and costly.

The work described in this paper has received funding by the German Federal Ministry of Education and Research (grant no. 01IS17029A) as well as the Federal Ministry of Economic Affairs and Climate Action (grant no. 03SX540D)

Although current Autonomous Underwater Vehicles (AUVs) have left the area of research, they are used mainly for underwater perception, e.g. large distance inspection or large area monitoring. AUVs like ALIVE, SAUVIM and GIRONA 500 are going a step further in trying to enable subsea systems to autonomously interact with their environment, forming the class of *Intervention AUVs* (I-AUVs). A good overview on the evolution of such systems is given in [3]. While recent works are even targeting cooperative autonomous subsea manipulation [4], and AI techniques are helping to raise the autonomy of AUVs [5], autonomous subsea intervention has not yet found its way into the maritime industry.

The AUV *Cuttlefish* described in this paper is our latest addition to the still relatively small number of these I-AUVs, developed with some unique aspects like dual manipulators and the hydrobatic capability to take arbitrary poses in the water column to interact with otherwise difficult to reach objects.

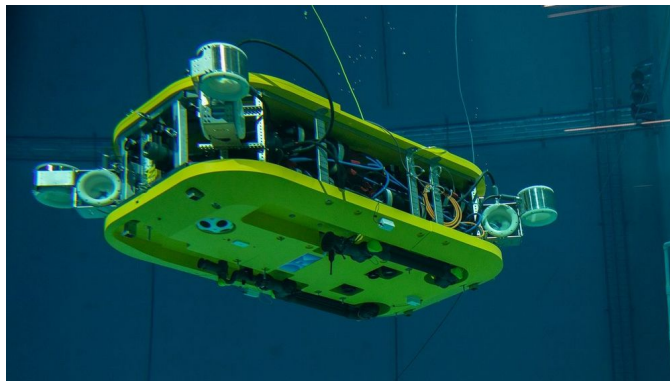

Fig. 1: The dual-arm intervention AUV *Cuttlefish*

The following sections are targeting the mechatronic design, especially the idea how to switch between a purposely unstable system to a more stable configuration in the water column for manipulation purposes, the design of the underwater manipulators and the intra-vehicle communication setup. The subsequent sections are then focussing on the algorithmic and software details, giving an insight on the used framework, the control scheme utilizing mixed-integer quadratic programming (MIQP) and model-based feedback linearization

as well as discussing manipulator control using MoveIT and the chosen close-range navigation approach. The paper is also highlighting the areas, where AI techniques can help to overcome problems of more conventional approaches. In the final section, we will summarize the experiences made during the first underwater trials and give an outlook on future developments of intervention AUVs and the *Cuttlefish*.

II. ROBOTIC CONCEPT

The AUV *Cuttlefish* was specifically designed for autonomous manipulation of subsea structures, with the following main and unique features to enhance the current state of the art in intervention AUVs: 1) the ability to take arbitrary poses in the water column to reach even difficult to access objects with its two specifically designed manipulators, 2) the ability to change the center of gravity and the buoyancy to tune more towards stability when manipulating rigid structures or more towards agility during maneuvering and 3) a compliant docking interface with fast data transfer allowing for human remote control when docked aside from the autonomous operations.

While designing the internal and external communication of the system, we followed the paradigm that every data source should be a standalone TCP/IP communication node, so that not only internal subsystems, but also the remote control center as well as further third party data handlers could subscribe to the information needed.

Initial example application scenarios include contact inspection of foundation structures on wind turbines, of hydrogen pipelines and other underwater equipment such as valves or pumps in offshore fields, the assessment of galvanic anodes and unexploded ordnance disposal preparations and other salvaging operations. In addition to the operation modes described above, it is possible to operate the vehicle in a hybrid mode using an optical fiber using the integrated battery management system (BMS) for critical operations on underwater structures without a preinstalled docking interface. For this purpose, the vehicle has a variety of optical and acoustic sensors for environmental awareness, described in the following sections.

III. MECHATRONIC DESIGN

A. Vehicle

The structural concept is based on 13 pressure hulls, that are embedded in a stainless steel open frame construction (see Fig. 3). The intended neutral buoyancy is realized with a PVC based foam (Divinycell HCP50, Diab Group) placed on the top and bottom of the AUV, with the foam being segmented into separate modules. This allows for different configuration of the foam so that the buoyancy can be adapted to the installed payload. The decentralized design concept with self-sufficient sensor, computing and actuation units distributed to multiple pressure compartments has advantages also on the experimental setup. The option to easily change the weight distribution according to the current application allows to keep the AUV orientation intentionally unstable in the water column

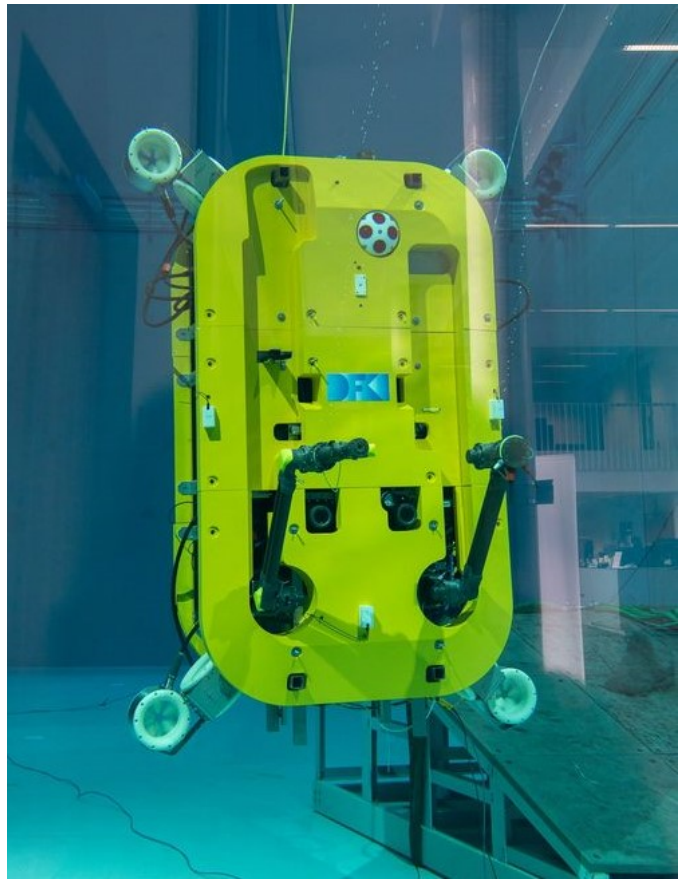

Fig. 2: *Cuttlefish* during trials in the underwater test basin of the German Research Center for Artificial Intelligence (DFKI).

by moving the center of mass and center of buoyancy at a point close to each other. With this property and by using eight powerful rim thrusters specifically developed for *Cuttlefish* by Wittenstein cyber motor GmbH with the ability to be controlled also at very low RPM, the AUV can be precisely actuated in all 6 DOF. This allows *Cuttlefish* to keep a stable orientation while manipulating subsea structures with its two robotic arms. As an additional option, the AUV can perform a motor driven linear shift of its two battery compartments, with a weight of 250 kilograms in air via an actuator and a threaded spindle. The relocation of this counterweight with a negative buoyancy of approx. 1000 Newton shifts the center of mass as well as the volume distribution to increase the hovering stability during dual arm manipulation. The current AUV setup is shown in Fig. 3, the actuator for the battery movement is depicted in detail in Fig. 4. The disadvantage of the decentralized design is, that a high number (43) of underwater cable connections is required. To be able to mount all the respective 86 connectors as well as to maximize the structural stiffness and thus increasing the possible diving depth, each of the 26 compartment caps have been designed with a dome shape. The basic specifications of the AUV are depicted in Table I.

TABLE I: Vehicle Specifications

Specification	Value
Length/ Width/ Height	2,8m/ 2,0m/ 0,8m
Weight	1200 kg
BMS	2x 5kWh LiFePo batteries, 50V
Diving Depth	Initial 300m, designed for 1000m
Thrusters	8 Wittenstein rim thrusters (500N each)
Speed	4 kn
AUV Payload	120kg
Sensor	Rowe SeaPilot; IMU IXblue Phins C3 Tritech Micron DST CHIRP Sonar Pressure Sensor Keller PAA-33x
Communication	USBL Evologics S2CR 18/34
Camera	3 x Basler ACE 2040-25GC
Manipulators	2 elec.-mec. arms (4 and 6 DOF, see sec. III-C)

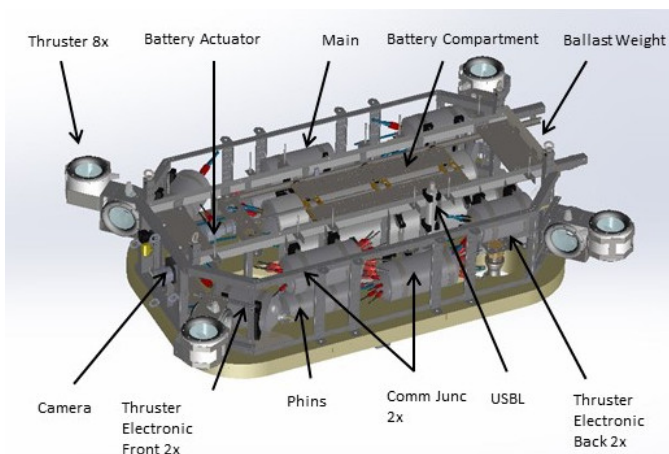

Fig. 3: Cuttlefish system overview

B. Electronics

Essential electronics for control and power management are distributed over four pressure housings: The Main compartment embeds one computer for navigation and computer vision (Kontron mITX-CFL mainboard equipped with an Intel i7-8700 processor and 32 GB of RAM) as well as one dedicated computer for logging purposes (SUPERMICRO X10SDV-6C+-TLN4F with Intel Xeon D-1528 processor). One ad-

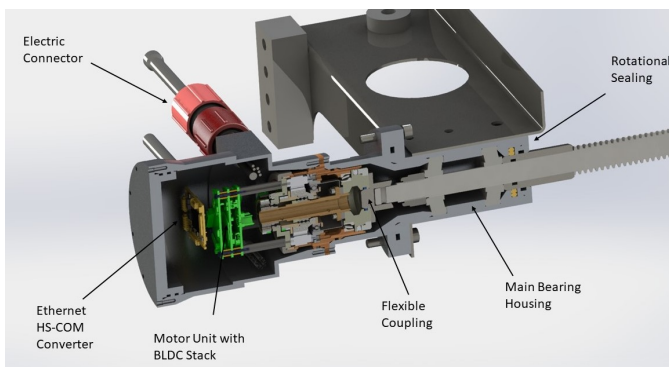

Fig. 4: Battery Actuator

ditional single board computer (Hardkernel Odroid XU4) serves hardware related tasks specific to this compartment. It is connected via Ethernet to two other pressure housings (called *communication-junction compartment*) which deliver hardware interfaces to external devices like IMU, sonars, cameras, lamps, pressure sensor, thruster communication etc. This design was chosen in order to address the large number of devices to be connected via cables and connectors. The size of the AUV also required a solution which reduces overall length of underwater cables. Instead of having one pressure housing connecting to all sensors and actuators all distributed over the AUV these two *communication-junction compartments* can be placed more in the front and the rear of the AUV close to the devices to be connected. Each of those compartments contain voltage converters, an Ethernet switch, devices used for power distribution and management as well as one single board computer (Hardkernel Odroid XU4) for hardware management of the corresponding compartment. Devices with interfaces other than Ethernet, like RS485 for the lamps or RS232 in the case of the depth sensor, are connected via serial device server dovetailing the architectural concept are also located in each *communication-junction compartment*. One pressure housing is dedicated to high-power management which handles two battery inputs and one input for charging the batteries. It provides the AUV with two power outputs: one uninterrupted power supply for all electronics like main boards and one for the thrusters. Due to the large scale of the AUV and its requirements for maneuverability eight very high power thrusters were chosen for propelling which made it reasonable to supply those thrusters with their own supply channel, capable to deliver up to 12.5 kW of continuous power. Most interfaces of the pressure housings do use gigabit-Ethernet because it is very robust to ground noise and can easily be used. Thus also Ethernet is used for communication to both arms. Choosing ethernet as a preferred method of communication simplifies cable management since connections of devices outside the pressure housings are more flexible and furthermore reduce the needed variety of underwater connectors. This is why the AUV is mainly equipped with just two types of connectors: An ethernet connector shared with power for sensors and most actuators as well as one-pin connectors for high power delivery, both sourced from MacArtney-Subconn.

C. Manipulators

Cuttlefish is equipped with two manipulator arms that were developed and built in house. With one manipulator, referred as the *docking arm*, the system can dock to the fixed infrastructure parts in order to perform local manipulation tasks precisely in an energy-saving manner. Also, the docking interface is intended to be used for high-speed communication. On the second manipulator, named the *manipulation arm*, various working tools can be mounted, depending on the requirements of the specific tasks. Both arms are designed for operating depths up to 6000 meters. For this purpose they can be filled with oil for pressure compensation and must be connected to a pre-tensioned pressure compensation unit via a

TABLE II: Manipulator Specification (without payload)

Specification	Docking arm	Manipulation arm
DOF	4	6
Length	1306 mm	1686 mm
Mass in air	12.35 kg	14.18 kg
Mass in water	8.7 kg	9.8 kg
Mass in water with oil filling (for pressure compensation)	10.2 kg	11.5 kg
Payload in water	11 kg	7 kg
Payload in water with oil filling	10 kg	7 kg
Drives operating voltage	48 V DC	
Logic operating voltage	12 V DC	
Operating depth	30 m	
Operating depth with oil filling	6000 m	

self-locking quick connector at the base. Table II summarizes the most important technical data of both manipulators.

The housing parts of the drives and most parts of the supporting structure of the manipulator arms are made of aluminum alloy EN AW-5083. This alloy is known to show good corrosion resistance in salt water and is easy to machine. To increase the corrosion protection and surface hardness of the components, the parts were coated with a 50 μm ceramic layer (hard anodizing). Some parts of the supporting structure which have a too complicated shape for machining, e.g. the tube support between DOF 2 and 3 (see Fig. 5), were manufactured using an investment casting process. For these parts, the alloy Anticorodal-72 was used and also hard anodized resulting in a hardened layer of roughly 50 μm . To reduce the mass of the manipulators, the connecting tubes between DOF 2 and 3 are made of carbon fibre-reinforced-polymer (CFRP) and glued into the tube supports. Although it is planned to equip the manipulators with force-torque sensors for proper force control of actuators, no commercial solutions that fulfilled the requirements regarding the maximum operating depth in the water, dimensions and corrosion resistance could be identified yet.

The docking arm has four joints and a gripper, that is able to clamp onto a ball head connected to the infrastructure (see Fig. 5a). The solution with the ball head coupling is necessary to reduce the load on the arm, since the arm is mechanically not able to absorb all the forces that could act on the AUV in strong water currents. Due to the spherical shape of the coupling, the AUV can still move around the infrastructure, where the manipulator holds it at a fixed distance to the docking point. Therefore, the actuators and the supporting structure of the arm are not overloaded, and the thrusters are relieved, saving energy. Moreover, the working range of the AUV increases in comparison to a fully fixed docking setup.

Fig. 6 shows the gripper coupled to the docking interface. The docking interface (1) is mounted on the stationary infrastructure. Due to the generic mounting method (screw-on flange with 8 M6 screws), the interface can be attached at arbitrary positions with little effort. To commission the high-speed data transmission, only the internal Wi-Fi antenna (4) has to be connected to the Wi-Fi transceiver with two coaxial

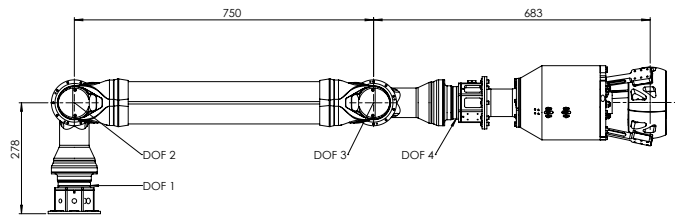

(a) 4DOF arm (docking arm)

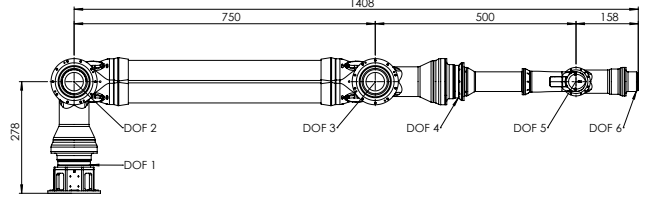

(b) 6DOF arm (manipulation arm)

Fig. 5: Morphology and dimensions of the Cuttlefish manipulators

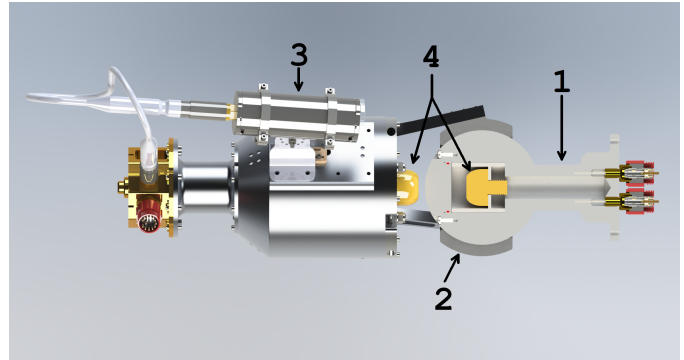

Fig. 6: Cuttlefish docking gripper with docking interface connected to the infrastructure (1, sectional view), three spherical gripping jaws (2, sectional view), camera unit for marker detection and visual serving (3) and Wi-Fi antennas (4)

connectors. A second Wi-Fi antenna is integrated in the gripper and is connected to the Wi-Fi transceiver of the AUV. A smart camera (3) is installed on the gripper housing to detect the markers on the infrastructure and to adjust the positioning of the gripper if necessary (visual servoing). In order to reduce the load on the data bus of the manipulator and not to transmit raw camera images, a Raspberry Pi nano, responsible for image and position recognition, is integrated in the camera housing. The estimation of the relative pose of the camera with respect to the infrastructure by using ArUco markers takes place on the SBC. Only the rotation and translation of the detected markers are transmitted via network to the central navigation stack. Whereby a local control of the robotic arm is conceivable as well. In real experiments it was shown that markers with high redundancy but at the same time good detectability under poor visibility conditions are very computationally intensive. Due to the limited computing

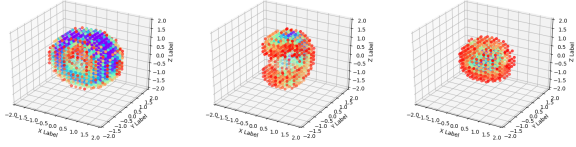

Fig. 7: Reachability maps for exemplary joint configurations of the 6 DOF manipulator. The left figure shows the largest workspace and corresponds to the chosen design.

capacity of the SBC, a trade-off had to be found.

The second arm is a manipulator arm with 6 DOF (See Fig. 5b), intended to accommodate sensors, grippers and other various tools, that can be screwed to the last joint. The power lines (12 V and 24 V) and the communication bus (high-speed LVDS) of the manipulator are available for this purpose. If necessary, the payload can also connect to the central pressure compensation system of the manipulator. The power and data lines as well as pressure compensation medium are routed through the hollow shaft of the last actuator directly to the payload. The design of the 6 DOF manipulator was aided by a reachability analysis: to maximize the manipulator’s dexterity, the reachable workspace was calculated for different joint configurations using the forward kinematics and compared to derive the most suitable design. Exemplary reachability maps are shown in Fig. 7.

D. Underwater Communication

The AUV Cuttlefish is equipped with an underwater high speed communication interface and is thus able to transmit sensor data from cameras, laser scanners or various payloads to a control center via the corresponding docking interface. The interface is bidirectional, i.e. data can also be transmitted from the infrastructure to the AUV. In the initial design, a maximum achievable data rate of 100 Mbit/s was specified. The communication interface is integrated into the 4 DOF docking arm and enables wireless communication with the infrastructure. For this purpose, a two-channel single band (2.4 GHz) MIMO antenna with an omnidirectional radiation characteristic is integrated into the end effector and the docking sphere of the infrastructure. Despite the fact that the excitation frequency of water is 2.4 GHz, a maximum netto data rate of about 70 Mbit/s could be achieved under real conditions with salt water (1.8%). The best transmission conditions were achieved in a corridor of 30 mm to 60 mm, which corresponds approximately to the $\frac{\lambda}{4}$ and $\frac{\lambda}{2}$ line of the transmission frequency as depicted in Fig. 8. At higher distances, the achievable bandwidth decreases significantly due to the strong attenuation and can no longer be used effectively. To improve the radiation characteristics, the antenna is mounted flat on a metallic ground plane. Furthermore, only fiberglass-reinforced plastic screws were used in the antenna’s radiation area to prevent interference. Testing of the interface in the overall system is still pending.

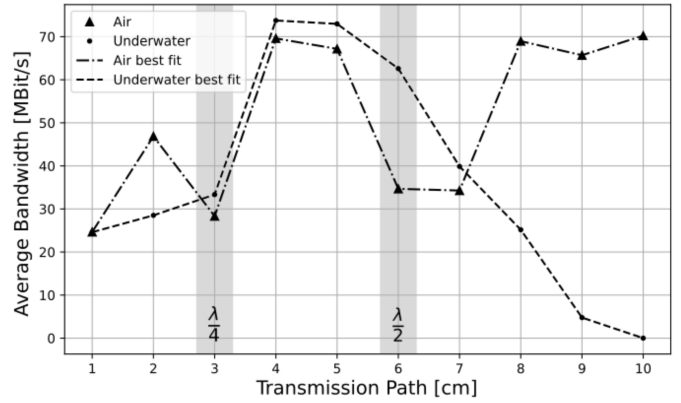

Fig. 8: Average bandwidth over the transmission path compared in air and underwater.

IV. CONTROL

A. Software Framework

The entire software stack is running in an Ubuntu 18.04 docker container on the systems main PC. The docker image that is used is developed with the docker image development¹ workflow and mounts the ROS [6] melodic workspace, located on the host. A bridge nodelet is running inside the docker container, which converts low level communication from serial and UDP interfaces to ROS messages.

B. Vehicle Control

The main challenges of controlling Cuttlefish are due to its hydrobatic nature and thruster performance limitations. This especially impacts the orientation control performance [7]. As a hydrobatic vehicle, Cuttlefish can assume any arbitrary orientation, in particular, a pitch angle of 90 degrees. Therefore, the orientation can not be represented using Euler angles due to singularities. Instead, quaternions are used for representation and rotation matrices are used for the orientation controller. The overall control architecture, as shown in Fig. 9, consists of a two-layered cascaded PID controller in combination with feedback linearization. The first layer of the cascaded controller are control laws for position and orientation. The position is controlled by a proportional control law. The orientation control based on rotation matrices is derived from [8]. The output of the first layer, i.e., the reference linear and angular velocity used as inputs to the second layer, are subject to saturation, reflecting the actual ability of the vehicle. When tuned correctly, this control design eliminates overshooting the target position and orientation.

The second layer consists of six independent PID controllers for linear and angular velocities. Finally, feedback linearization based on an approximate model of the vehicle is used to compensate for hydrodynamic effects, restoring forces and moments.

The control allocation for Cuttlefish takes thruster performance limitations, e.g. thrust saturation and deadzone, into

¹github.com/dfki-ric/docker_image_development

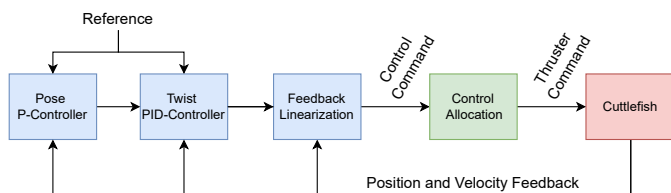

Fig. 9: Cuttlefish Vehicle Control Architecture, consisting of cascaded PID controller for position and velocities in combination with feedback linearization. The control commands (given as generalized forces and torques) are mapped to the individual thrusters by the control allocation.

account. The control allocation is therefore formulated as an optimization problem, more specifically as a mixed-integer quadratic program (MIQP).

C. Manipulator Control

The manipulator arms are controlled with ROS. In order to communicate with the low level NDLCOM protocol [9], used by the motor stacks, an NDLCOM-ROS bridge and a multithreaded joint driver have been developed. For improved performance, they run within one nodelet. Each joint has its own driver instance, which inherits from ROS RobotHardwareInterface and thus enables the use of preexisting ROS controllers and the ROS controller manager. Being this tightly integrated with ROS facilitates using the ROS based MoveIT library [10] for trajectory planning and execution. MoveIT is configured with the URDF description of the entire system including both arms. This allows to generate and follow trajectories with both arms simultaneously with self-collision avoidance. Planning and trajectory execution can be triggered via the rviz GUI, which allows selecting predefined poses or move the end-effectors to a desired position. Additionally, a package is written that interfaces MoveIT and exposes trajectory planning and execution as ROS action servers, which has several advantages. For one, the extra interface allows sending planning request that define the end effector pose in a different reference frame, e.g. a marker. Secondly constraints can be added to the planning requests. Furthermore, the availability of action servers allows interacting with behavior trees based on the `py_trees_ros`² package. Behavior trees are used to describe and compose complex tasks in a tree like graph structure. Several scenarios are defined as task sequences with predefined end effector goals, which can be loaded at runtime via generic auto generated GUIs in rqt or html. The fundamental ROS package is wrapped to add additional features that facilitate operator interaction, e.g. permission control. This allows to execute subtasks like planning autonomously, while waiting for operator permission for more critical tasks like trajectory execution.

²wiki.ros.org/py_trees_ros

A. Overview

The navigation system design needed to reflect the vehicle's capability to switch between the travel- and manipulation configuration. Both configuration have their own specific requirements: during travel a geo-referenced and long-term stable navigation is needed, while during manipulation additional asset-relative navigation is required. The final navigation design uses a iXBlue Phins C3 inertial navigation system as main component, which provides orientation and acceleration as sensor data as well as filters for additional sensors in conjunction with a comprehensive library of sensor communication protocols. The additional sensors used are a pressure sensor (Keller PAA-33x), a USBL (Evolgics S2CR 18/34) and a DVL (Rowe SeaPilot). All sensors are connected using Ethernet as data transport interface. Equipped with these sensors the Phins C3 is capable of providing an error-bound, DVL-aided dead-reckoning localization data mainly to be used in the travel configuration. Since all the experiments with the AUV system were performed in-doors (test basin at DFKE-ERIC), a camera-based localization system (see section V-C) was used to provide GPS-like data while the vehicle was surfaced, mimicking real GPS data in open water, which is also sent to the Phins C3 and used for initialization. When the vehicle rotates into the manipulation configuration it loses ground-lock with the DVL (which is mounted on the bottom of the AUV alongside the manipulators), greatly reducing the position accuracy. To remedy this, a stereo camera was mounted near the DVL, which faces the asset during manipulation tasks. Using fiducial markers on the asset together with the respective computer-vision algorithms an asset-relative localization can be performed, circumventing the Phins C3 filters and directly providing a localization solution to the navigation framework. The following sections will give more detail on the respective parts of the overall localization system.

B. Visual Asset-relative Localization

This navigation input is used when the AUV has rotated into the manipulation configuration. The bottom-mounted stereo camera system then faces the asset which is to be manipulated. By articulating the asset with fiducial markers (modified AprilTags [11] in this case, see Fig. 10), it is easy to compute relative position and orientation even with a monocular camera (an approach which can even be enhanced by adding magnetometers, see [12]). Assuming the position of the markers is known, this way an asset-relative positioning is possible. The calculated pose of the marker is handled similar to USBL input in the standard navigation and directly sent to the Phins C3 for processing. The reason for utilizing a stereo camera system is twofold: for one during manipulation tasks partial occlusion by the manipulator are possible, and secondly the 3d-structure of the asset itself can be recovered. The latter is not yet implemented but has high potential value for the future: this way it could be possible to compare the measured 3d structure of the asset with a-priori-information (e.g. from

CAD) in order to assess damage, marine growth or similar alterations. For cases where no marker-based solutions are feasible, a second relatively small Waterlinked A50 DVL was acquired, to be mounted at the rear of Cuttlefish providing speed over ground information while in upright orientation.

C. Camera-Based Indoors Localization

One of the problems of the underwater basin at DFKI-RIC is the GPS-shielding effect of the building on top of the basin. This prevents the utilization of initialization routines, which are typically carried out on the surface of a body of water using GNSS signals. To remedy this, a camera-based localization system was implemented for the basin: a set of four machine-vision cameras were mounted under the roof, together covering the complete 437m² surface area of the basin. The images from these cameras are processed by a computer running a number of computer-vision algorithms on them. First the four images are rectified and mosaiced into a complete view of the surface (requiring prior camera calibration), and then a fiducial marker tracking algorithm, similar to V-B, is used to find markers. Their position in camera-frame is then transformed into a GPS frame (which was computed once during installation by use of aerial views of the building) and published as NMEA GPS positions. This means that by simply attaching a fiducial marker on top of a robot a GPS-like position can be obtained even though inside a building. In case of the Cuttlefish the NMEA message only had to be routed to the cuttlefish-network and could then directly be used by the Phins C3 as input for the localization filter.

VI. SUMMARY AND OUTLOOK

While first test in the large test basin at DFKI RIC have been successful and the performance of *Cuttlefish* is promising so far, the way towards real autonomous underwater intervention in industrial settings is a long one. With our latest addition to the currently small class of intervention AUVs and the described unique features (hydrobatic agility, stable dual-arm manipulation in arbitrary poses, decentralized concept with standalone sensors and actuators, etc.), we hope to shorten that path a little. The scientific work and testing of behaviors for proper autonomous operation of *Cuttlefish* has just begun, but we are looking forward to the challenges ahead and think we have an exciting system basis for that now. Also, we think the transfer of research to and from other challenging areas like AI-based space- and SAR robotics is crucial and will further accelerate the development of such autonomous systems.

Currently, the Cuttlefish dynamic vehicle model, used for simulation and control, is time invariant. As such, it does not adapt to changes in the model due to varying payload, the manipulation of objects and other effects during longterm missions. Modern techniques in the field of artificial intelligence enable the online learning of hydrodynamic models [13]. To improve control performance, it is foreseen to apply this method to Cuttlefish.

In future planned research, the dual arm manipulation functionality will be exploited further. In that scope a full body

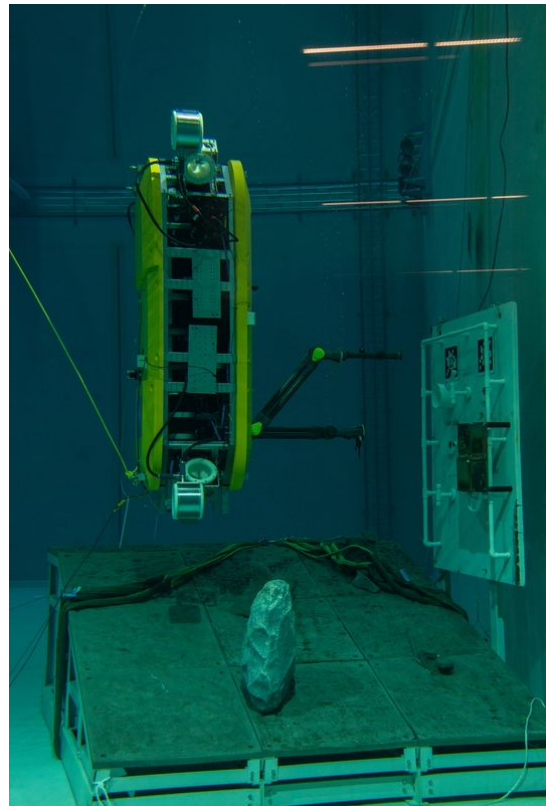

Fig. 10: Cuttlefish in front of the asset mock-up with fiducial markers.

admittance control approach could be explored to compensate disturbances of strong water currents and minimize the forces on the docked end effector.

In an effort to prepare the developed system for autonomous long term missions, the behavior tree control approach could be enhanced to support different autonomy levels. Furthermore, it would be desirable to enable the behavior tree to automatically start and stop required ROS nodes at runtime.

Concerning the short range navigation close to subsea structures, it is planned to integrate and test the use of multiple magnetometers distributed on the system to localize in learned static magnetic field distortions of such structures as described in [12].

ACKNOWLEDGMENT

The authors would like to thank our industrial partners that accompanied the development of the AUV, i.e. WITTENSTEIN cyber motor GmbH, ROSEN Technology and Research Center GmbH and SAP SE, especially Dr. Ralf Kruse, Dr. Manuel Quack, Dr. Peter Kampmann and Dr. Albrecht Ricken. Also the input from our colleagues at DFKI COS and DFKI EI was of great help to push the development. Finally we would like to thank all colleagues here at the DFKI Robotics Innovation Center that helped in realizing this amazing robotic system.

REFERENCES

- [1] J. Lee and F. Zhao, "Global wind report 2021," Global Wind Energy Council, Tech. Rep., 2021.
- [2] N. Fortuna, "Divers needed," *UnderWater Magazine*, vol. May/June, 2021.
- [3] P. Ridao, M. Carreras, D. Ribas, P. J. Sanz, and G. Oliver, "Intervention auvs: The next challenge," *IFAC Proceedings Volumes*, vol. 47, no. 3, pp. 12 146–12 159, 2014, 19th IFAC World Congress. [Online]. Available: <https://www.sciencedirect.com/science/article/pii/S1474667016435494>
- [4] R. Pi, P. Cieślak, P. Ridao, and P. J. Sanz, "Twinbot: Autonomous underwater cooperative transportation," *IEEE Access*, vol. 9, pp. 37 668–37 684, 2021.
- [5] L. Christensen, J. de Gea Fernández, M. Hildebrandt, C. E. S. Koch, and B. Wehbe, "Recent advances in ai for navigation and control of underwater robots," *Current Robotics Reports*, 2022.
- [6] Stanford Artificial Intelligence Laboratory et al., "Robotic operating system." [Online]. Available: <https://www.ros.org>
- [7] T. Rossol, C. Koch, R. Bachmayer, and F. Kirchner, "Necessity of hydrostatic stability in autonomous underwater vehicles on intervention missions," in *OCEANS 2022 - Hampton Roads*, 2022, unpublished.
- [8] N. A. Chaturvedi, A. K. Sanyal, and N. H. McClamroch, "Rigid-body attitude control," *IEEE Control Systems Magazine*, vol. 31, no. 3, pp. 30–51, 2011.
- [9] M. Zenzes, P. Kampmann, M. Schilling, and T. Stark, "Simple Protocol for Heterogeneous Embedded Communication Networks," in *Proc. of the Embedded World Exhibition and Conference*, Nürnberg, Germany, February 2016.
- [10] D. Coleman, I. Sukan, S. Chitta, and N. Correll, "Reducing the barrier to entry of complex robotic software: a moveit! case study," *arXiv preprint arXiv:1404.3785*, 2014.
- [11] E. Olson, "Apriltag: A robust and flexible visual fiducial system," in *Robotics and Automation (ICRA), 2011 IEEE International Conference on*. IEEE, 2011, pp. 3400–3407.
- [12] M. Hildebrandt, L. Christensen, and F. Kirchner, "Combining cameras, magnetometers and machine-learning into a close-range localization system for docking and homing," in *OCEANS 2017 - Anchorage*, 2017, pp. 1–6.
- [13] B. Wehbe, "Long-Term Adaptive Modeling for Autonomous Underwater Vehicles," Ph.D. dissertation, Universität Bremen, Jul. 2020.